

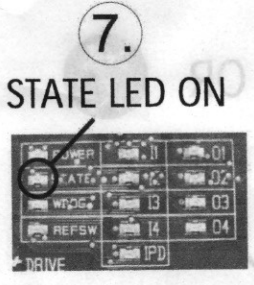

E/M/S ELECTRONIC EXCHANGE PROCEDURE Operating Instructions

Code PM.9.002315.EN
Version 0
Date 15.12.2011
Page 1.2

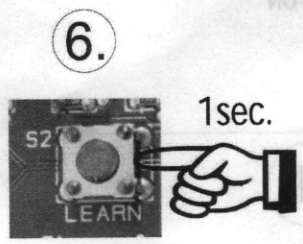

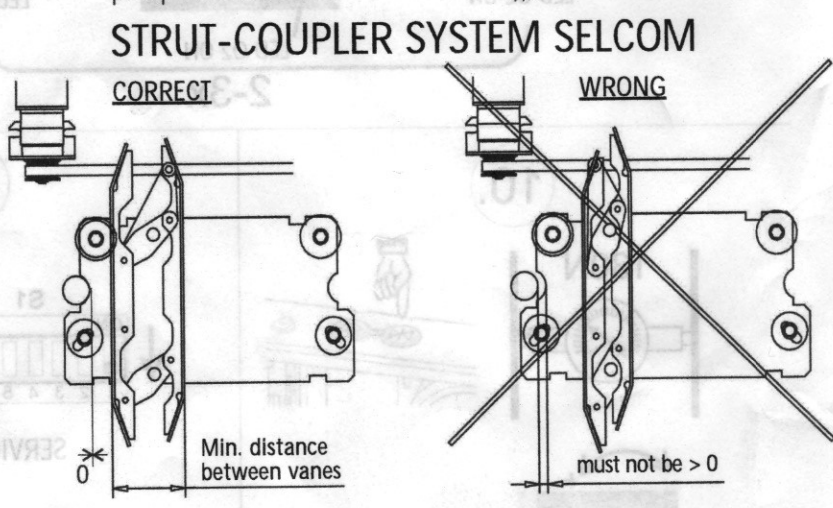
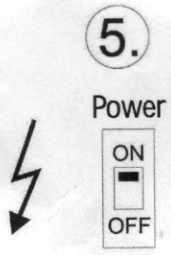
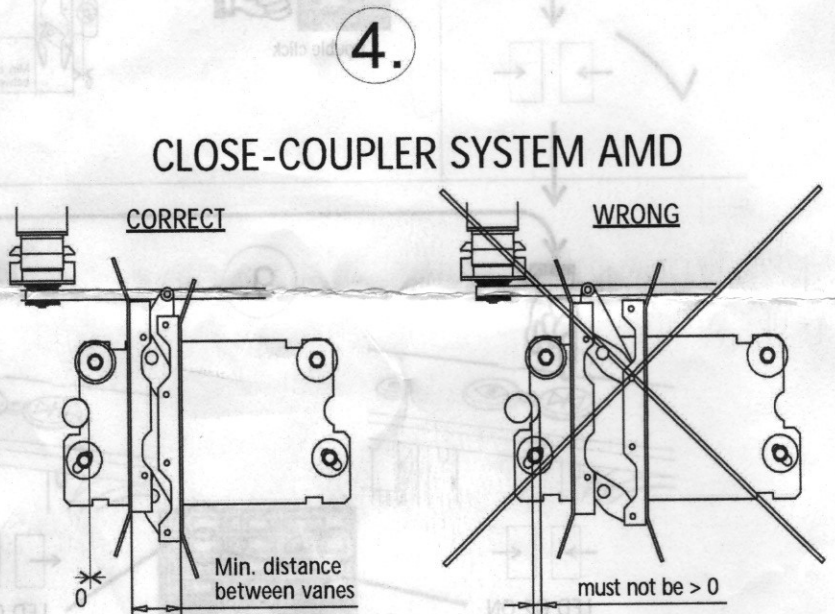
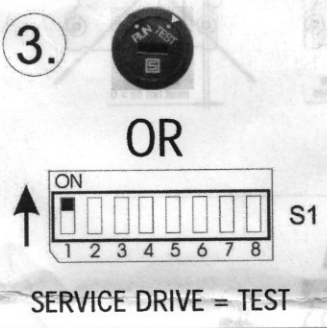
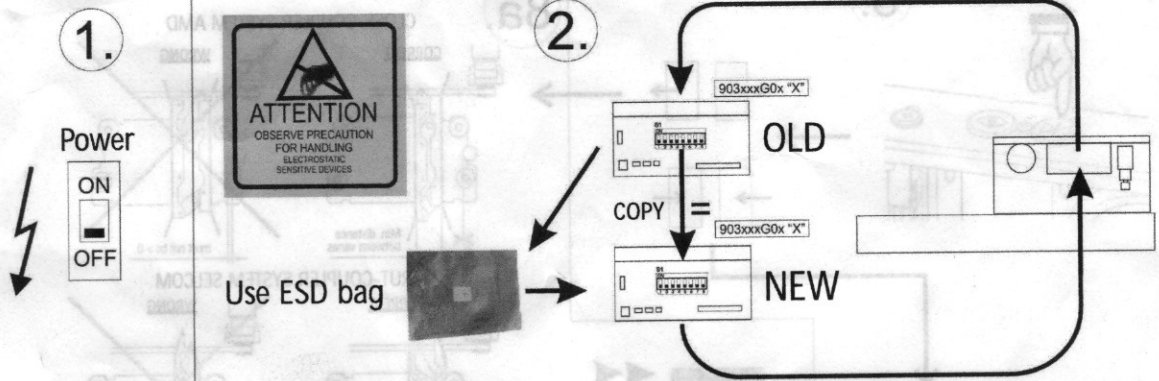

WITTUR

E/M/S ELECTRONIC EXCHANGE PROCEDURE Operating Instructions

Ver. 1.3
Date 18.12.2011
Page 1.3

Code PM.9.002315.EN
Version 0
Date 15.12.2011
Page 2.2

